

### Installation

**BioClad PVC is a very versatile system which can be easily installed in almost any building.**

#### Wall Preparation

Walls should be level and flat. Remove high spots and fill low spots. BioClad adhesive can be applied to any solid wall or wall surface, eg plaster, gypsum, board, brick, poured concrete, concrete block etc. it can also be applied directly to tiled surfaces that are firmly fixed to the wall. All surfaces must be dry and clean.

#### Cutting

A jigsaw is the best method of cutting the sheeting. A fine toothed hand saw can also be used.

#### Joining

Fully sealed joints are made using BioClad high impact PVC Silicone free gasket trim system which incorporates a co-extruded seal unique to BioClad. Joints can also be welded upon request.

#### Internal/external corners

BioClad PVC is normally thermoformed on site, so window and door reveals are neatly clad without an edge joint.

#### Fixing

Sheets are fixed using a fully bonded method with a trowel for BioClad adhesive (or gun applied polymer adhesive subject to wall substrate).

#### BioClad Panel Adhesive

This provides a quick and simple method to fit hygienic PVC cladding to most substrates. This polyurethane adhesive is applied to the back of the panels or onto substrate to give a solid all over bond.

The adhesive is easy to spread and should be applied with a notched trowel (see diagram). To ensure a 100% transfer of adhesive, apply firm, even pressure to the complete surface area when the panels are offered to the wall.

### Fitting

#### PVC 'H' Trim Single Part

This high impact PVC co-extrusion is fixed to walls and the sheets pushed into each section. The silicone free gasket joint ensures a water-tight seal that can be power hosed or handwashed and will provide a full sealed easy clean finish.

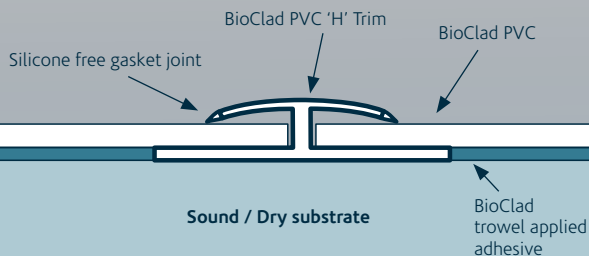

#### End stop / 'J' Trim

Manufactured and installed as the BioClad PVC 'H' trim. Can be used at the top, bottom and when starting / finishing cladding.

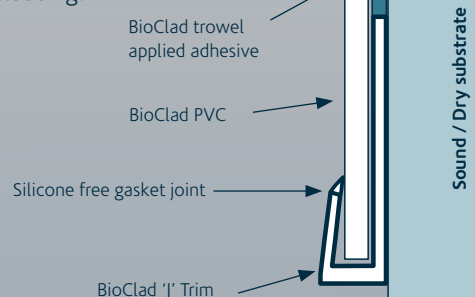

#### PVC 'H' Trim Welded

BioClad® can be cold or hot welded along its length to provide a sealed finish. N.B Not suitable for high temperature range changes.

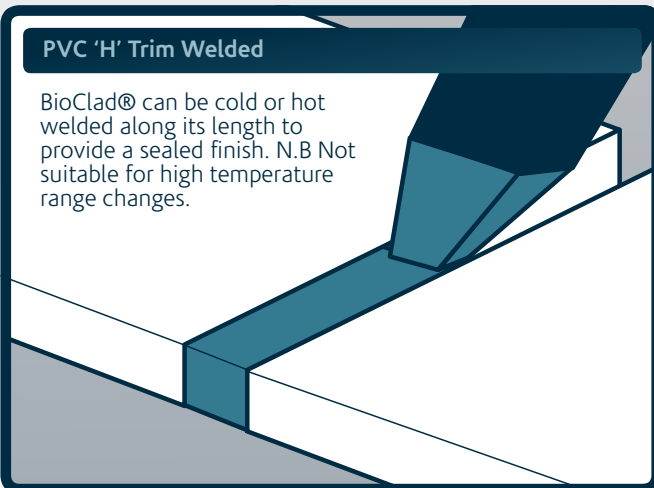

#### PVC 'H' Trim 2 Part

This high impact PVC co-extrusion is fixed to walls and the sheets pushed into each section. The silicone free gasket joint ensures a water-tight seal that can be power hosed or handwashed and will provide a full sealed easy clean finish.

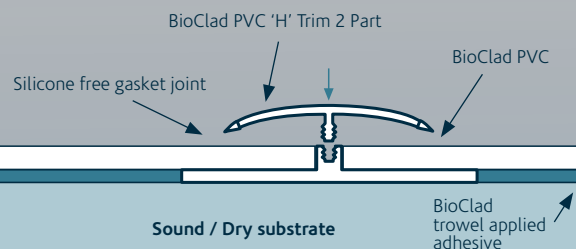

BioClad® reserve the right to change any product specification, design or description without prior notice. No responsibility or liability can be accepted for any loss or damage arising from any error or omission contained in this document.



### Fitting

#### Internal / External corners

Most cladding is fabricated on site and angles are carefully routed and thermoformed to give a smooth, easy to clean strong finish.

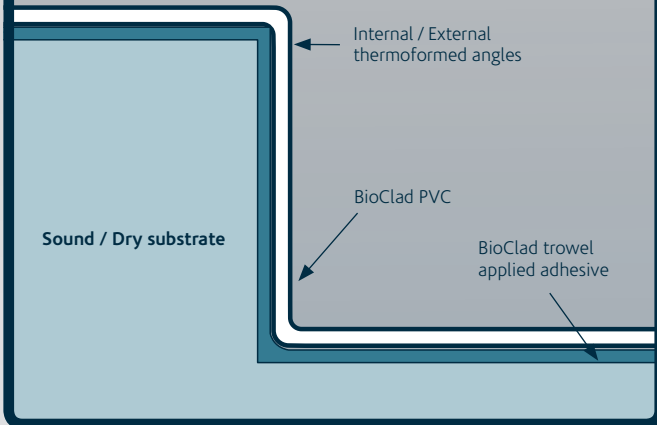

#### Window / Door openings

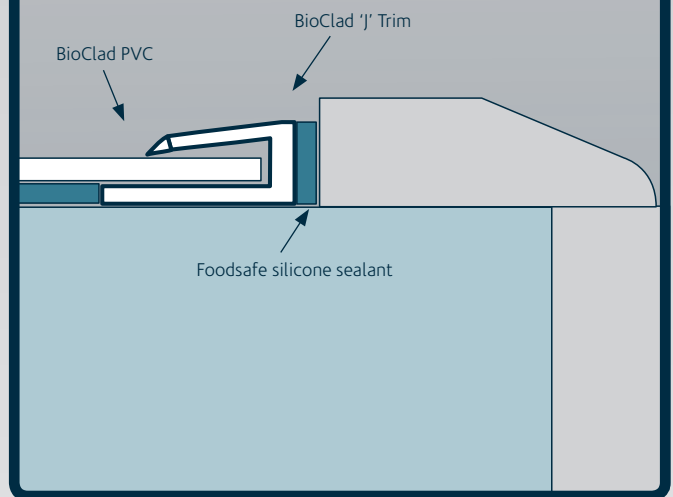

#### Vinyl floor detail

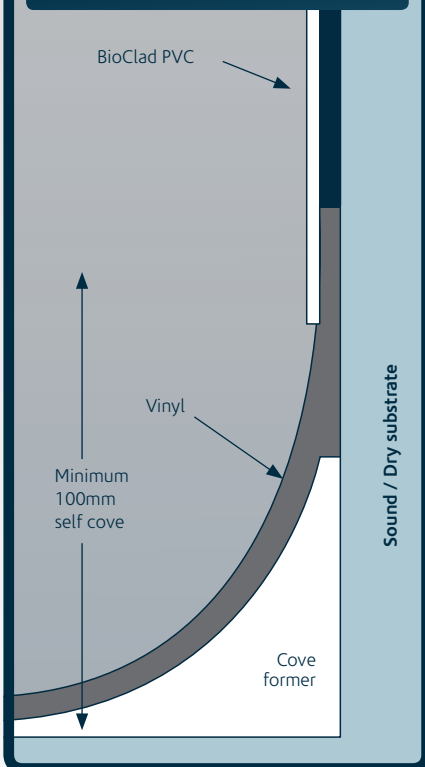

#### Vinyl floor 2 part joint detail

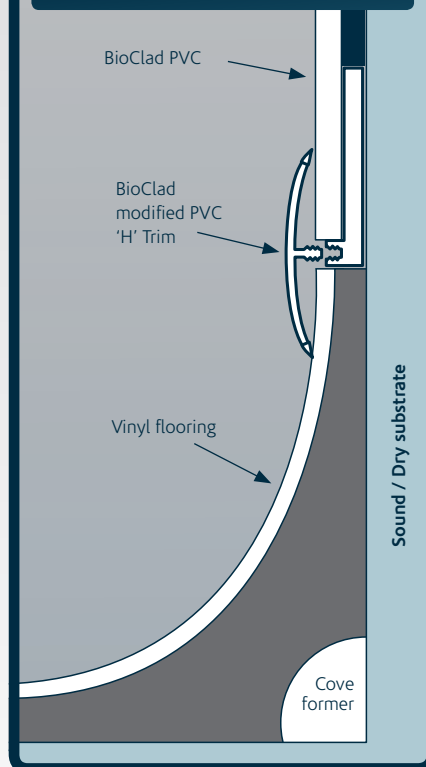

#### Quarry tile floor detail

